

TIMKEN

The Timken Company
4500 Mt Pleasant St. NW
N. Canton, OH 44720
Phone: (234) 262-3000

E-Mail: CustomerCAD@timken.com • Web site: www.timken.com

Part Number 3210 ATN1, Timken® Double Row Angular Contact Ball Bearings (3200, 3300)

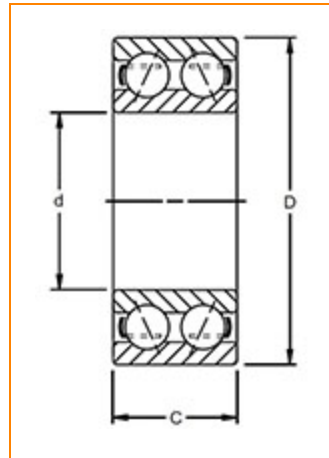

[Dimensions](#) | [Specifications](#) | [Basic Load Ratings](#) | [Abutment and Fillet Dimensions](#)

Dimensions

d - Bore	50.00 mm 1.9685 in
D - Outer Diameter	90.00 mm 3.5433 in
C - Ring Width	30.2 mm 1.1890 in
Contact Angle	30°

Specifications

Features	Open
Ball Type	STEEL
Age Type	Molded



Cage Material	Nylon
Bearing Weight	0.70 Kg 1.550 lb
Design Units	METRIC

Basic Load Ratings

C0 - Static Radial Rating	39900 N 8968 lbf
C1 ISO - Dynamic Radial Rating	43900 N 9867 lbf

Abutment and Fillet Dimensions

R - Inner Ring "To Clear" Radius ¹	1.10 mm 0.043 in
r - Outer Ring "To Clear" Radius ²	1.10 mm 0.043 in
da - Inner Ring Backing Diameter	57.0 mm 2.244 in
Da - Outer Ring Backing Diameter	83.0 mm 3.268 in

¹ Maximum housing fillet radius that bearing corners will clear.

² Maximum shaft fillet radius that bearing corners will clear.

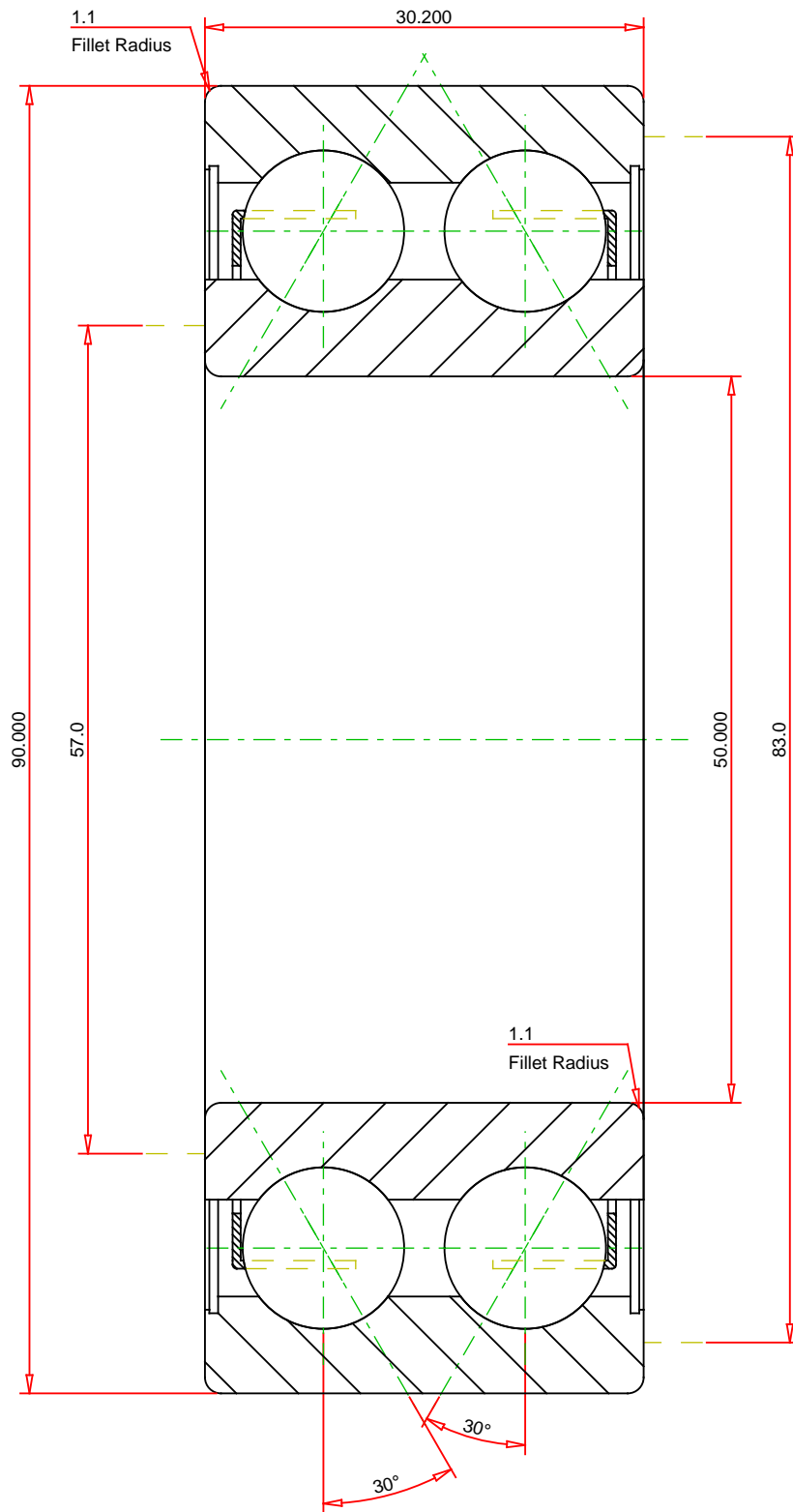

METRIC UNITS

Number of Balls Per Row	22
Bearing Weight	0.700 kg

TIMKEN®

THE TIMKEN COMPANY
NORTH CANTON, OHIO USA

3210 ATN1	
Timken® Double Row Angular Contact Ball Bearings (3200, 3300)	
Dynamic Load Rating	43900 N
Static Load Rating	39900 N

Every reasonable effort has been made to ensure the accuracy of the information contained in this writing, but no liability is accepted for errors, omissions or for any other reason.

FOR DISCUSSION ONLY